

# ANALYSIS OF THE EASTERN RANGE MULTIPLEXED FIBER OPTIC IRIG B120 DISTRIBUTION SYSTEM

Michael J. Duncan  
John S. Martell  
James L. Wright

Computer Sciences Raytheon  
Patrick Air Force Base Florida

## Abstract

*A study was conducted to assess the effects of transmitting a precision clock synchronization signal over a commercial multiplexed fiber optic communication system. This study is an evaluation of the distortion and jitter introduced into the signal by this type of transmission system. An analysis comparing signal quality at the multiplexing and demultiplexing ends of the fiber optic communication system shows that the amplitude and phase distortion added to the clock synchronization signal by the transmission system is minimal.*

## BACKGROUND

The Eastern Range (ER) provides launch and tracking support for commercial and Department of Defense missile launches from Cape Canaveral Air Force Station, Florida (CCAFS). In addition to the facilities at CCAFS, the ER consists of Florida mainland assets at Patrick Air Force Base (PAFB), the Jonathan Dickinson Tracking Annex, and the Malabar Tracking Annex. Down range stations are located in the British West Indies (Antigua Air Station) and at Ascension Island (Ascension Auxiliary Air Field) in the South Atlantic. These stations may be augmented with a range instrumentation ship, the USNS Redstone, to provide additional tracking coverage depending on the launch mission. In all, the ER tracking network provides over 4,000 nautical miles of coverage.

The ER timing system comprises a CCAFS range clock with subordinate station and site clocks. This system provides precise time and time interval signals that conform to the IRIG (Inter-Range Instrumentation Group) standard formats and are correlated to the DoD master clock to within 0.1 microseconds on the UTC (Universal Coordinated Time) scale. The station clocks distribute an IRIG B120 time-of-year signal to synchronize subordinate clocks. The IRIG B120 signal contains 100 bits per second of pulse width modulated serial data that is then amplitude modulated onto a 1 KHz sine wave carrier for transmission. Beginning each second, a reference marker in the signal indicates "on time". This is followed by days, hours, minutes, and seconds data. A formal description of this signal is available in document 200-89, *IRIG STANDARD TIME FORMATS*, available from the Range Commanders Council, White Sands Missile Range, New Mexico 88002.

## INTRODUCTION

As part of ER modernization, a FIBERMUX FX4400 multiplexed fiber optic communication system was installed in the Range Operations Control Center (ROCC) to transmit voice, data, and video information between the ROCC and the CCAFS communications distribution hub (XY Bldg.). The relevant portions of this system are shown in Figure 1. In this application, the system is configured as a FX4400 network utilizing approximately 120 single-mode fiber lines to provide communication services. One module in this system is used to distribute the IRIG B120 clock synchronization signal from the ER master clock. As part of the fiber optic system acceptance testing, a study was conducted to assess the capability of the communication system to transmit an IRIG B120 signal with minimal degradation.

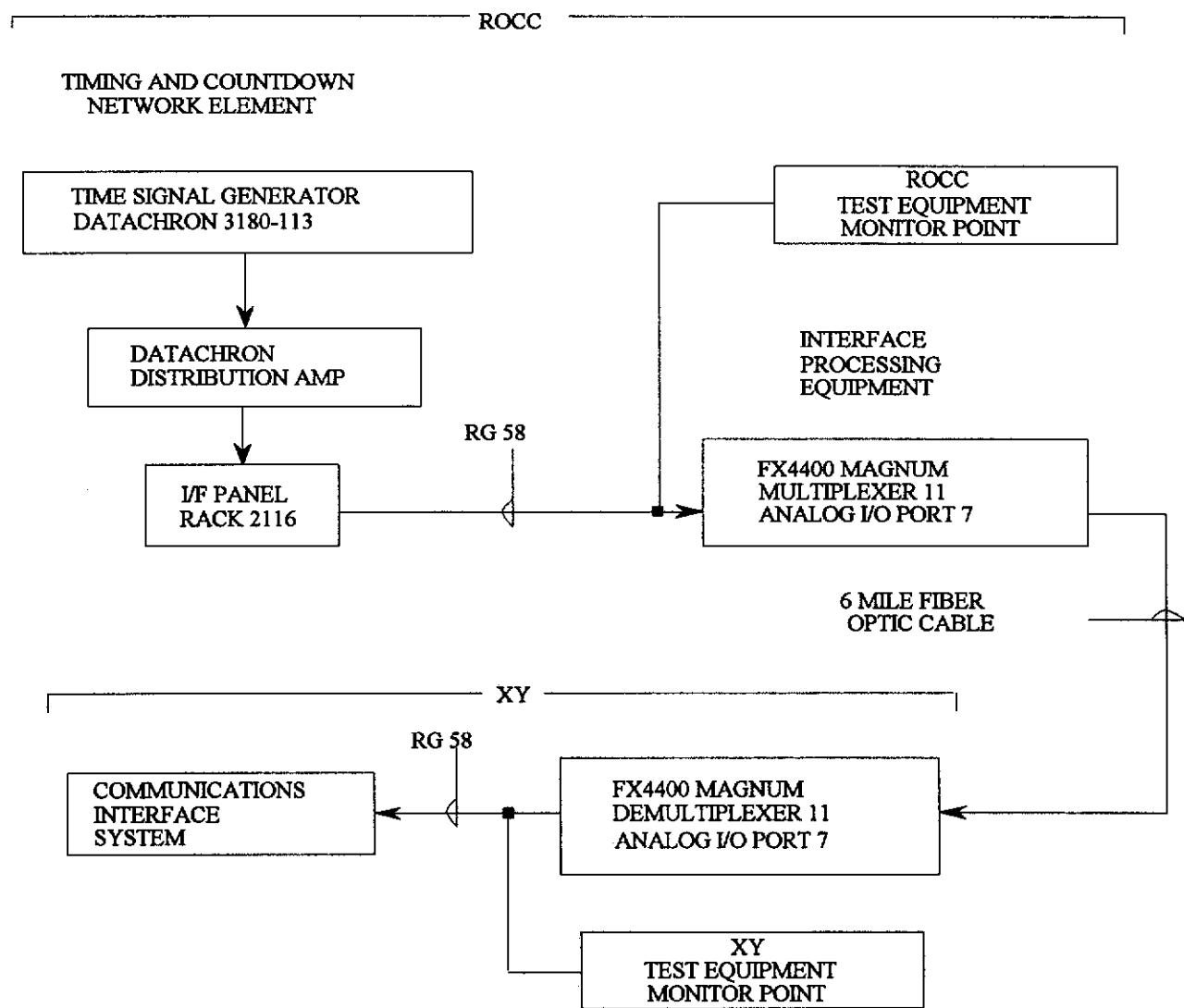

Figure 1. System Configuration.

The transmission of an amplitude modulated IRIG B signal over a commercial communication system is more difficult than it may first appear. The signal contains significant lower frequency (less than 300 Hz) components. The relatively large amplitude and importance of these low frequency components is due to the fact that the carrier is not sufficiently high in frequency to prevent negative frequency side-band harmonics from "folding over" into the signal. The loss of these low frequency components leads to unacceptable levels of amplitude and phase distortion. This precludes the use of a voice channel to transmit the signal. Instead, a FIBERMUX two channel CC4461G analog input card is used to multiplex the IRIG B120 signal onto the fiber optic system. This card has a 0 - 10 KHz bandwidth and has been optimized for use with a 1 KHz amplitude modulated signal. Reproduction at the demultiplexing end of the fiber is accomplished using a complementary CC4461 G/S card.

## ANALYSIS PERFORMED

The IRIG B120 signal was analyzed at the input to the multiplexed fiber optic communication system and at the demultiplexing end of the system approximately six miles away. These measurements were taken to evaluate the waveform shape, data errors, and the phase stability of the IRIG B120 signal after transmission over the fiber optic system.

Figure 2 shows the test configuration used at both ends of the system. The "IRIG B120 signal source" refers to the IRIG B120 signal provided to the CC4461G analog input card in the fiber optic multiplexing equipment at the transmitting end, and to the IRIG B120 signal reproduced by the CC4461G/S analog output card in the fiber optic demultiplexing equipment at the receiving end. At both ends, the IRIG B120 signal source was supplied to a Hewlett-Packard 54112D digital storage oscilloscope (DSO), a Hewlett-Packard 5372A frequency and time interval analyzer, and a Kinometrics 972-303 time code reader/tester. A reference one pulse per second (1 PPS) square wave was generated from a Hewlett-Packard 5061B cesium beam flying clock. This 1 PPS signal was provided as a trigger to the DSO and as a reference signal to the frequency and time interval analyzer.

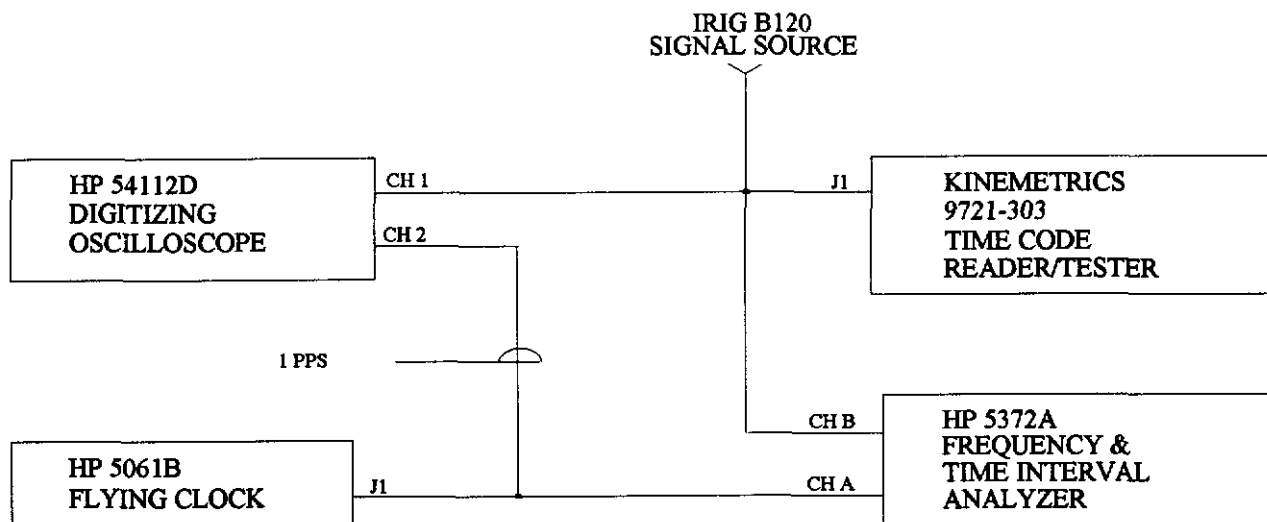
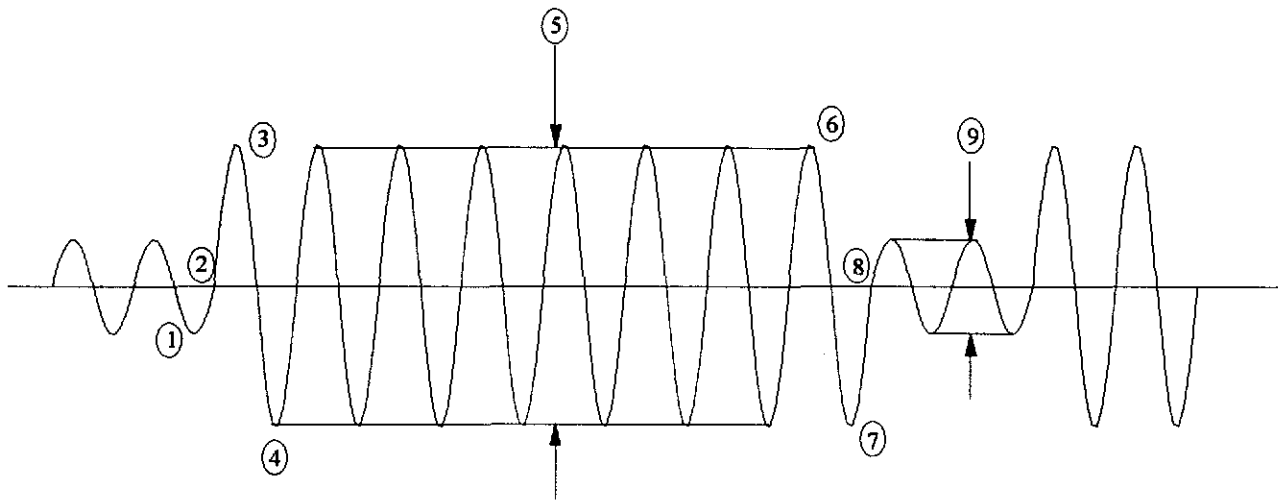

Figure 2. Test Configuration.

The IRIG B120 signal was first checked for distortion at both ends of the transmission system using the DSO. The analysis consisted of looking for signal deformation at nine specific points in the waveform. First, the IRIG B120 source signal was provided as input to channel 1 of the DSO. The 1 PPS signal from the flying clock was then aligned with the range master clock 1 PPS output and provided to DSO channel 2. Finally, the DSO was set to trigger on the leading edge of the flying clock reference 1 PPS. Several measurement sets were taken at both ends of the system for comparison. Figure 3 shows the nine areas where signal distortion typically occurs during transmission.



- |                                 |                                    |
|---------------------------------|------------------------------------|
| 1. pre-exalted cycle distortion |                                    |
| 2. zero cross-over distortion   |                                    |
| 3/4. exalted cycle distortion   |                                    |
| 5. exalted cycle stability      |                                    |
|                                 | 6/7. post-exalted cycle distortion |
|                                 | 8. zero cross-over distortion      |
|                                 | 9. non-exalted cycle stability     |

Figure 3. Typical IRIG B120 Signal.

A second series of tests were performed to evaluate the short term and longer term frequency stability of the IRIG B120 signal. The 1 PPS output of the cesium beam flying clock was aligned with the range master clock 1 PPS output. The 1 PPS output of the flying clock was then used as the start reference in performing direct time interval measurements versus the "on time" point (first positive zero crossing in a frame) of the IRIG B120 signal. In each test, one hundred measurements were made. Five series of tests were performed at each end of the fiber optics network. The time between samples (Tau) was increased after each test series. The first series was conducted with a Tau of one second. For each subsequent test series, the Tau was increased by an order of magnitude. In the final series of tests, a Tau of ten thousand seconds was used. This provided data on both short term signal stability and the long term signal stability trends. Tests were conducted sequentially, first at the transmitting end, and then at the receiving end of the fiber optic cable.

While the above test series were performed, the signal under test was monitored by the Kinometrics 972-303 Time Code Reader/Tester. This unit was used to monitor the signal for bit errors and code dropout.

## RESULTS

A comparison of results from the transmitting and receiving ends of the fiber optic cable showed no discernible distortion at any of the nine points of interest in the IRIG B120 signal (refer to Fig. 3). In addition, there were no bit errors or code dropouts detected at any time during the testing.

For the frequency stability tests, a statistical analysis was performed on each group of samples taken. The frequency and time interval analyzer was used to perform these calculations and display the results. The square root of the Allan Variance (Rt Al Var) was calculated to characterize the stability of the IRIG B120 signal. This variance was determined from the time interval measurements of the IRIG B120 signal versus the reference 1 PPS from the flying clock. This sampled square root Allan variance is the primary measurement used in the comparison tests between sample groups at the two ends of the transmission system. Table 1 describes the test series performed.

SAMPLE RATE, TAU (seconds/sample)	SAMPLE SIZE	TIME OF TEST (in seconds)
1	100	100
10	100	1,000
100	100	10,000
1,000	100	100,000
10,000	100	1,000,000

Table 1. Test Series Performed.

Table 2 shows the average results obtained from the transmitting and receiving ends of the fiber optic system. At the transmitting end, the average value for the standard deviation was 1.82304 microseconds, and the average value for the square root Allan variance was 1.73734 microseconds. The receiving end showed an average standard deviation value of 1.86320 microseconds, and an average square root Allan variance of 1.80689 microseconds.

Tau	TRANSMITTING END		RECEIVING END	
	Std. Dev. (x10 <sup>-6</sup> sec.)	Rt. Al. Var. (x10 <sup>-6</sup> sec.)	Std. Dev. (x10 <sup>-6</sup> sec.)	Rt. Al. Var. (x10 <sup>-6</sup> sec.)
1	1.89787	1.83203	1.79326	1.74611
10	1.90233	1.89802	1.85756	1.80097
100	1.71966	1.59866	1.90140	1.81727
1,000	1.69359	1.70912	1.78028	1.83392
10,000	1.90176	1.64888	1.98354	1.83620

Table 2. Frequency Stability Test Results.

Graph pairs 1a,b through 5a,b show the test measurement sets taken at the multiplexing and demultiplexing ends of the transmission system. Each of these graph pairs shows test samples on the x-axis, and has been scaled to show a time interval range of 20 microseconds on the y-axis. Please note that the time interval values show a fixed delay at both the transmitting and receiving ends of the system. At the transmitting end, this delay (approximately 115 microseconds) is caused entirely by the choice of triggering level used in the testing. The same triggering level was used at both test locations, and was chosen to minimize spurious readings caused by noise at the zero-crossing point. The magnitude of the delay is due to the slope of the IRIG B120 signal. At the receiving end the delay is approximately 305 microseconds. This includes a transmission delay in addition to the triggering level delay.

## CONCLUSION

Comparisons of the data collected at the multiplexing and demultiplexing ends of the transmission system indicate that a commercial multiplexed fiber optic communication system can successfully transmit a modulated IRIG B timing signal. The communication system tested in this study did not cause significant signal degradation or cause additional phase instabilities in the transmitted signal.

## GRAPHS

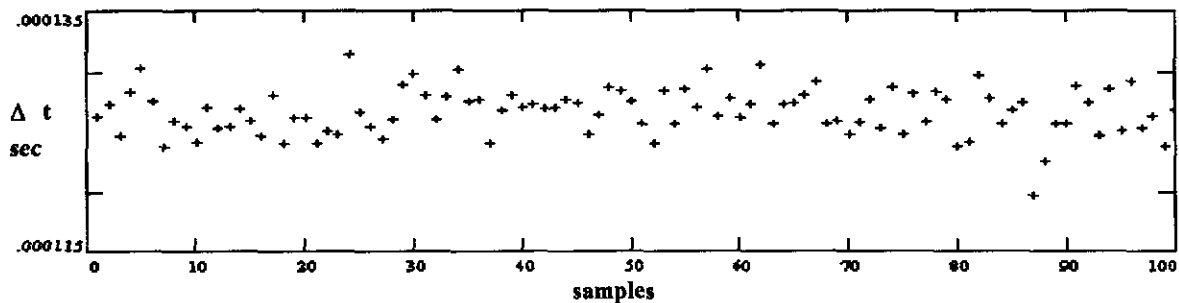

Graph 1a. Transmission End Time Interval Measurements (Tau = 1 seconds).

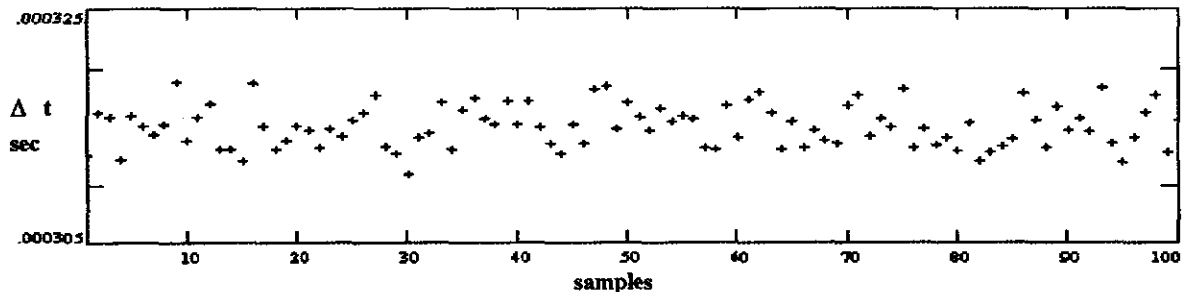

Graph 1b. Receiving End Time Interval Measurements (Tau = 1 seconds).

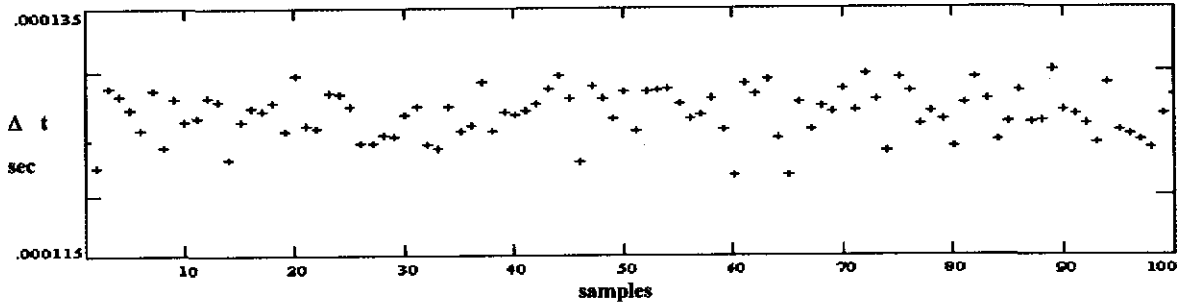

Graph 2a. Transmission End Time Interval Measurements (Tau = 10 seconds).

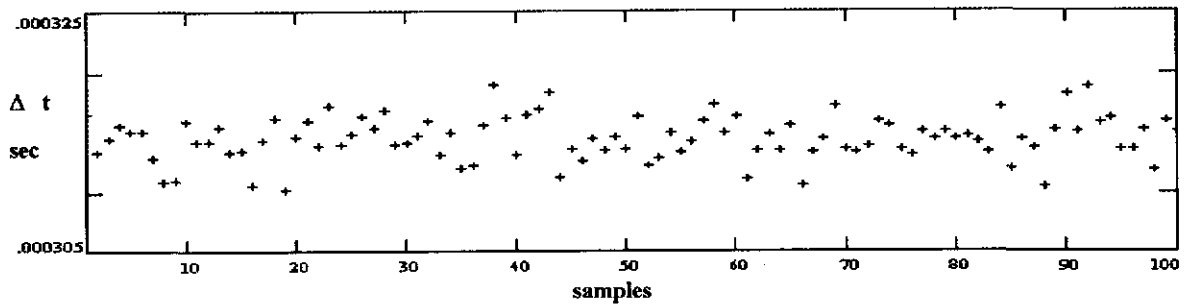

Graph 2b. Receiving End Time Interval Measurements (Tau = 10 seconds).

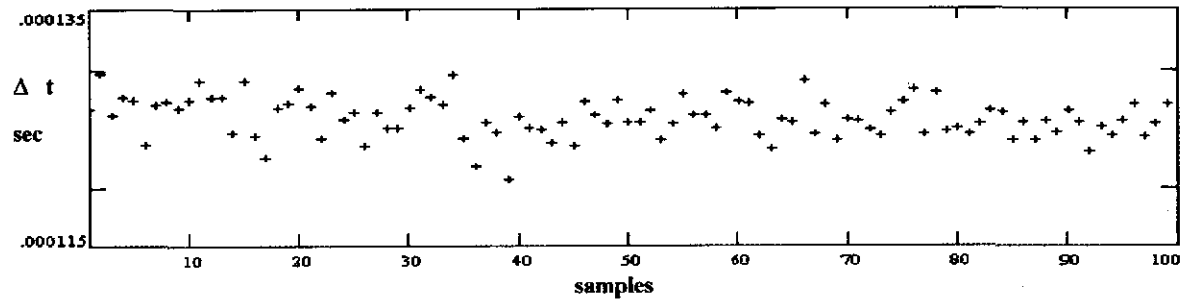

Graph 3a. Transmission End Time Interval Measurements (Tau = 100 seconds).

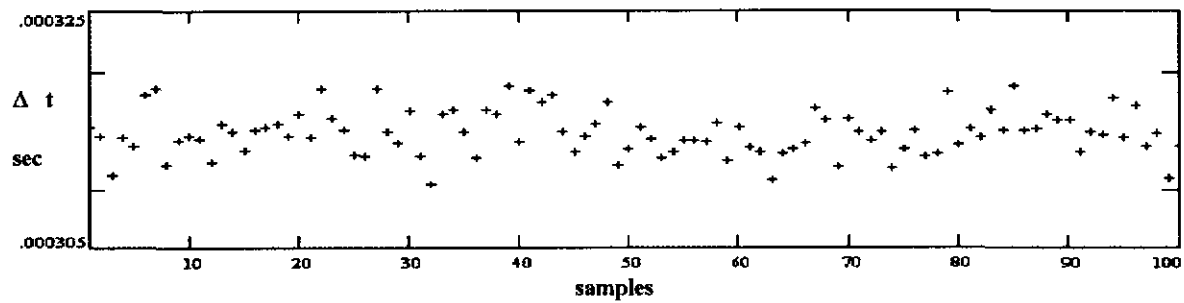

Graph 3b. Receiving End Time Interval Measurements (Tau = 100 seconds).

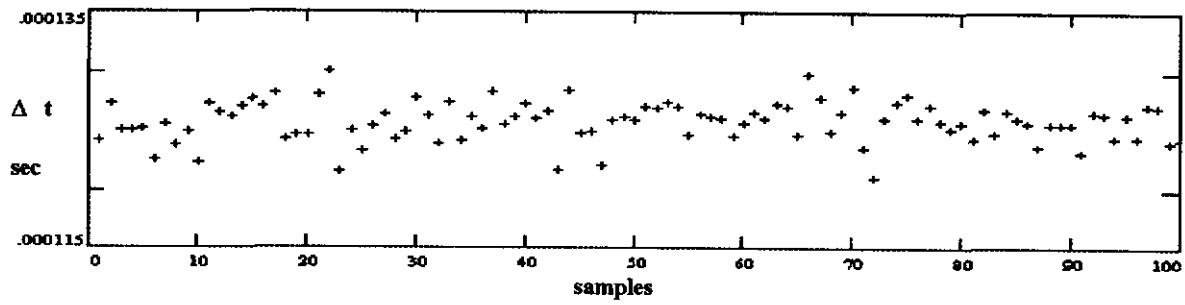

Graph 4a. Transmission End Time Interval Measurements (Tau = 1,000 seconds).

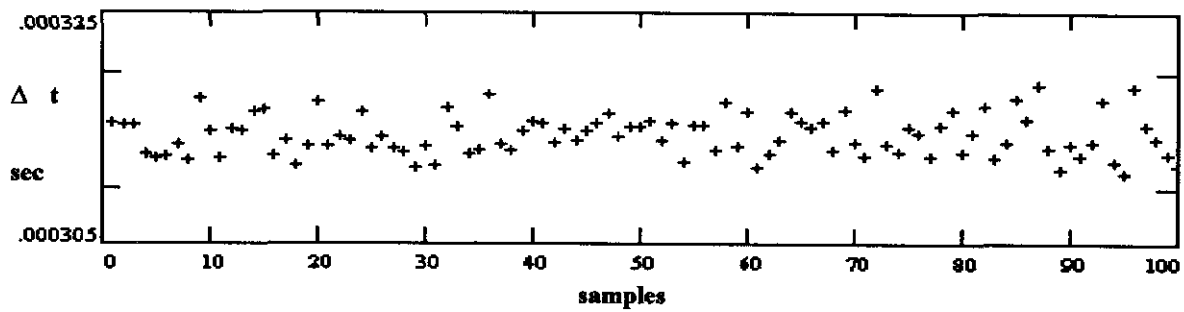

Graph 4b. Receiving End Time Interval Measurements (Tau = 1,000 seconds).

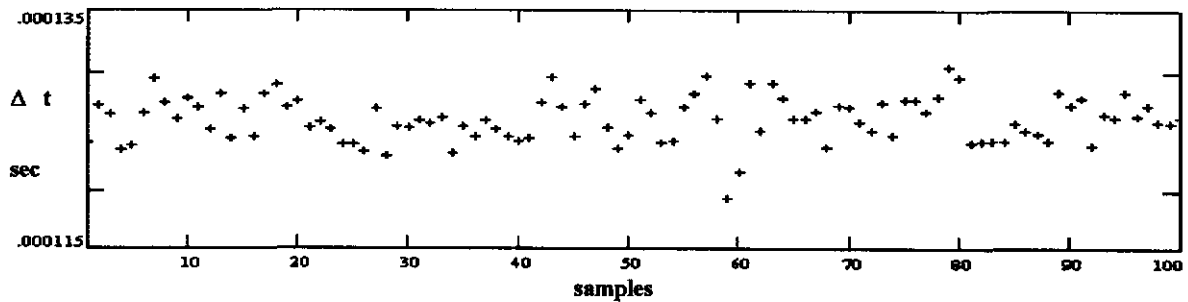

Graph 5a. Transmission End Time Interval Measurements (Tau = 10,000 seconds).

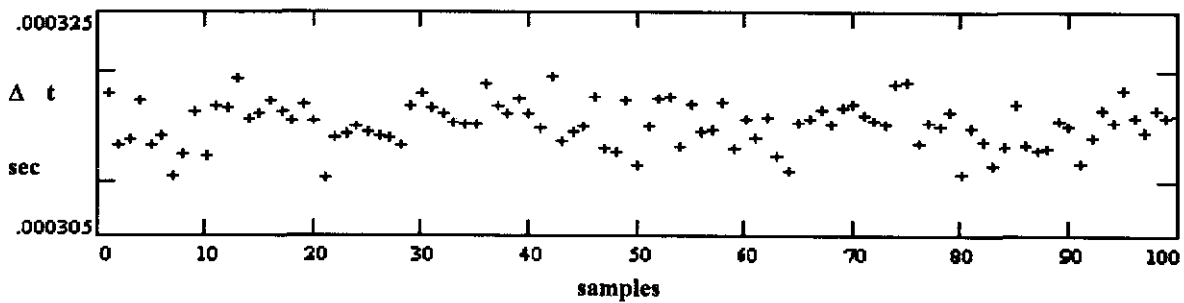

Graph 5b. Receiving End Time Interval Measurements (Tau = 10,000 seconds).



## REFERENCES

D. A. Howe and D. W. Allan, *Methods of measuring frequency stability*, NIST Time & Frequency Seminar, chapter 2, pp. 1-43, 1989.

D. A. Howe, D. W. Allan, and J. A. Barnes, *Properties of signal sources and measurement methods*, Proceedings of the 35th Annual Symposium of Frequency Control, 1981.

IRIG Standard 200-89, *IRIG Time Code Formats*, Timing Committee, Range Commanders Council Telecommunications Group, White Sands Missile Range, New Mexico, 1989.

Technical Report, *Transmission of IRIG Timing*, Communications and Data Transmission Committee, Range Commanders Council Tele-Communications Working Group, White Sands Missile Range, New Mexico, 1968.